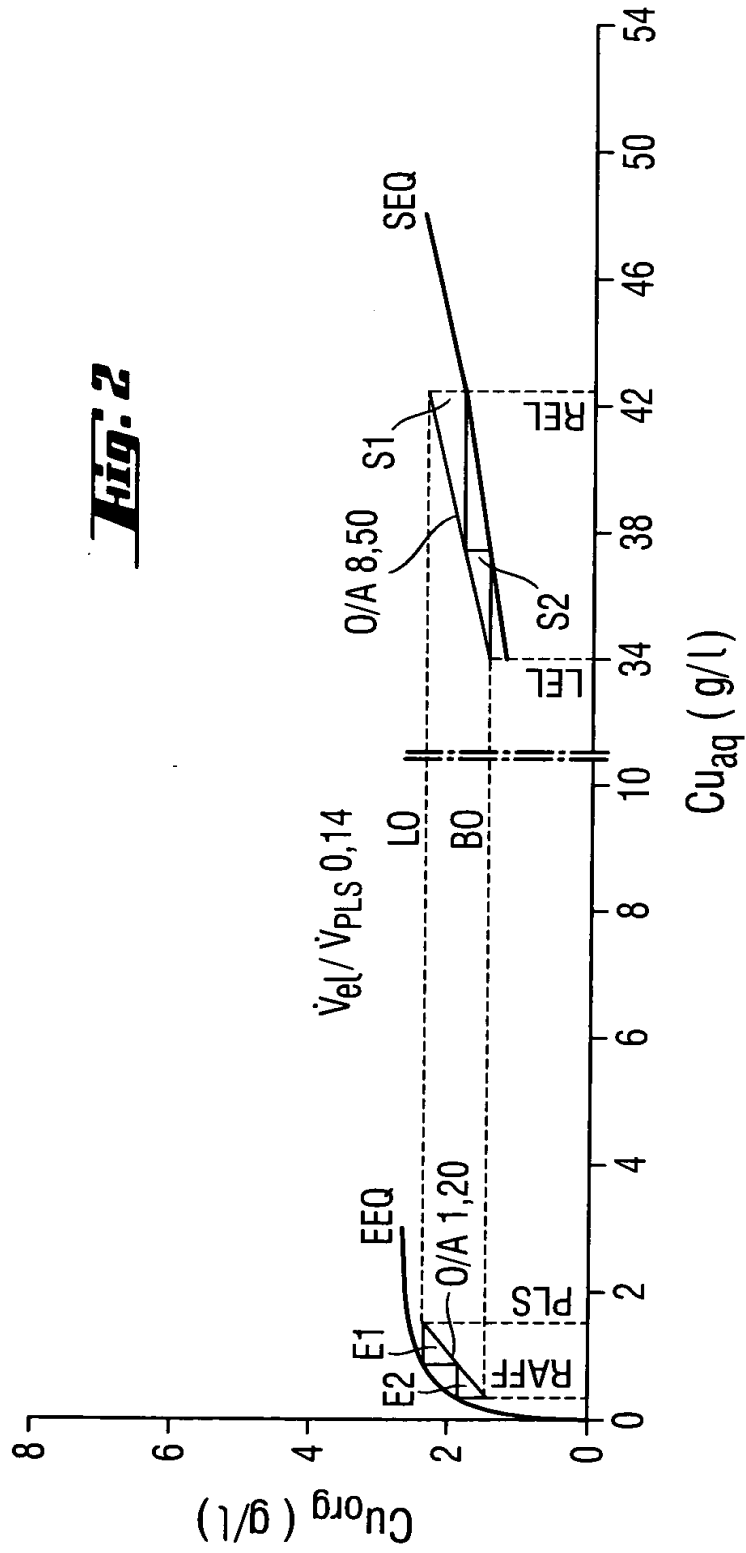


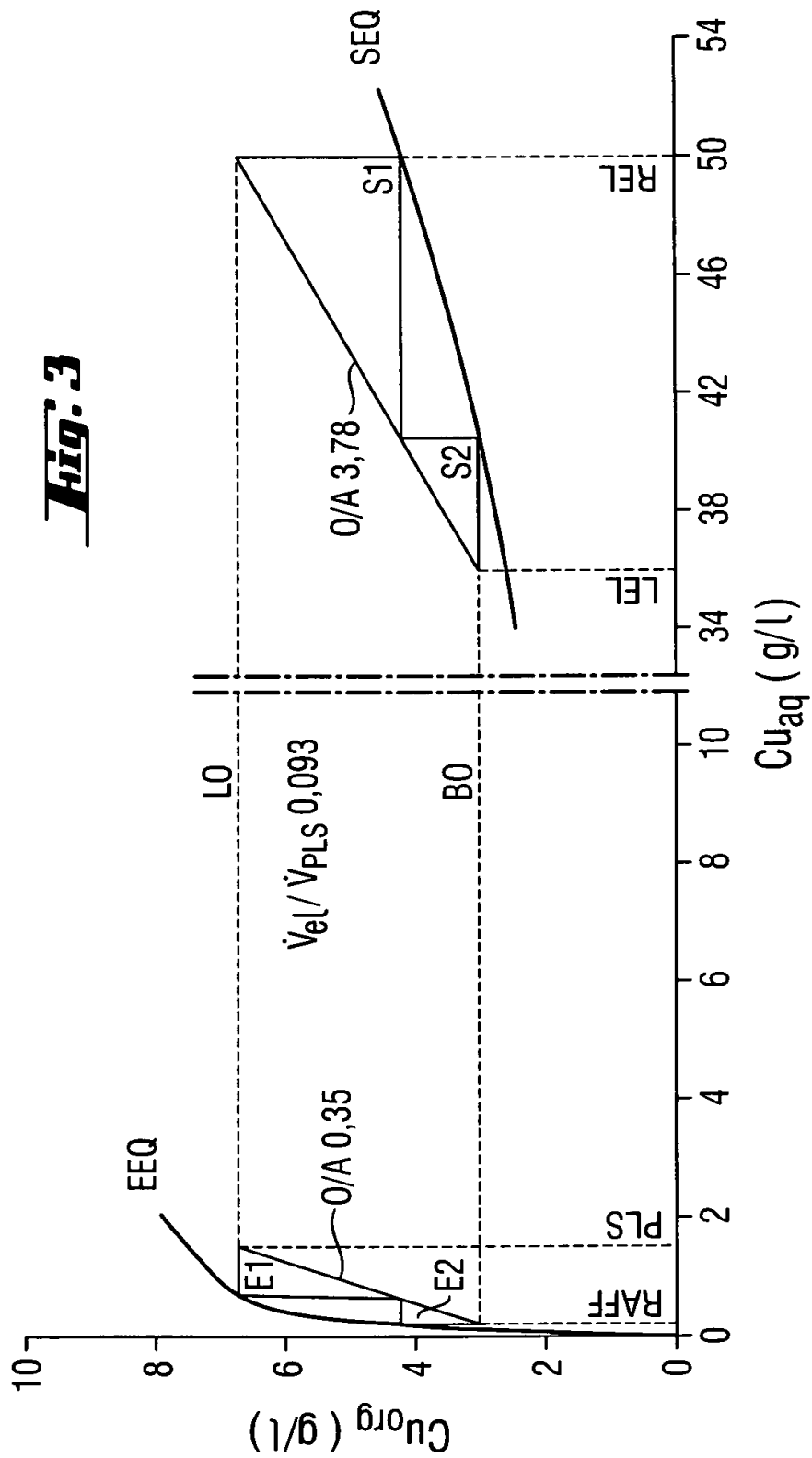
**Fig. 1**

**Fig. 2**

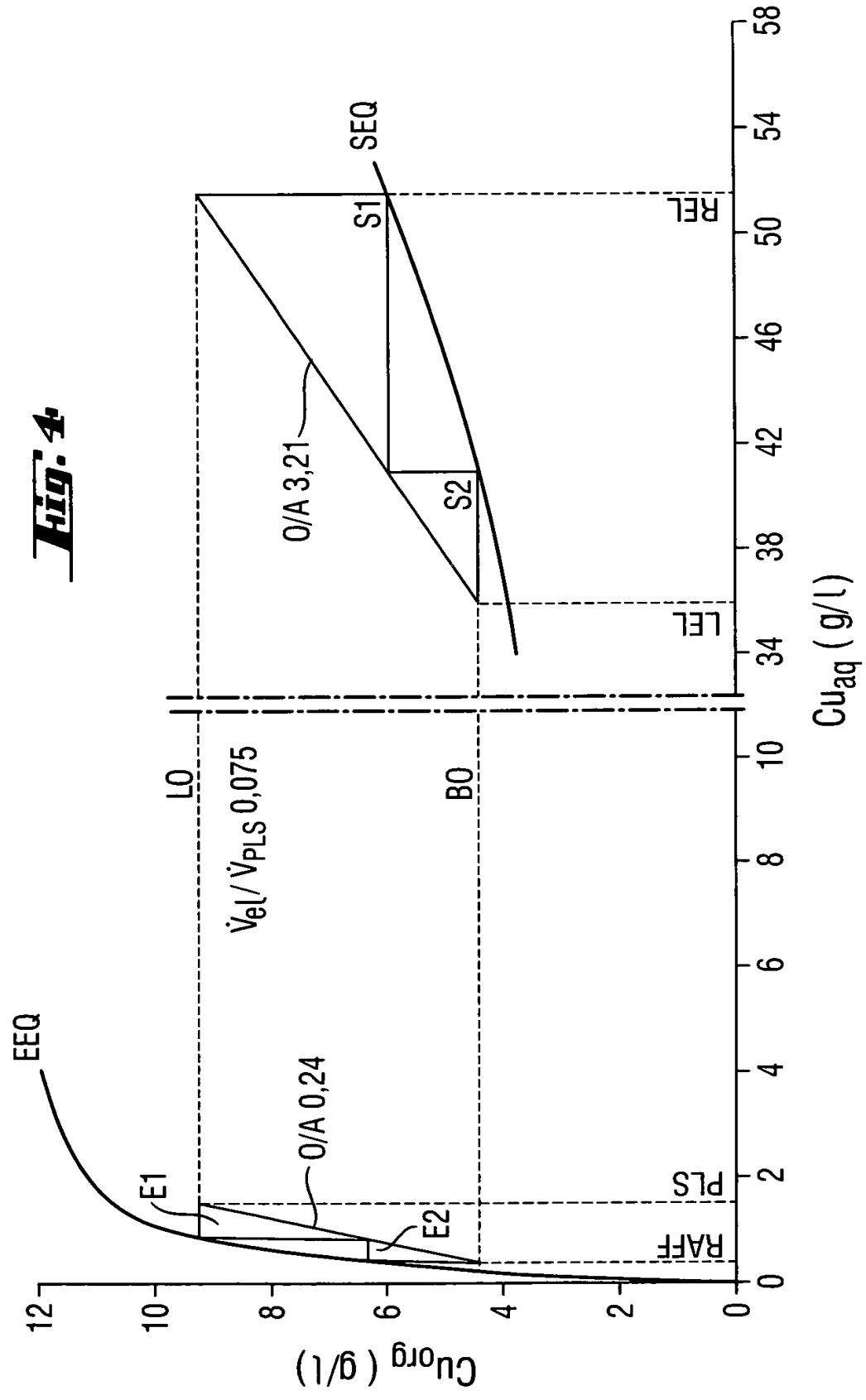


3 / 12

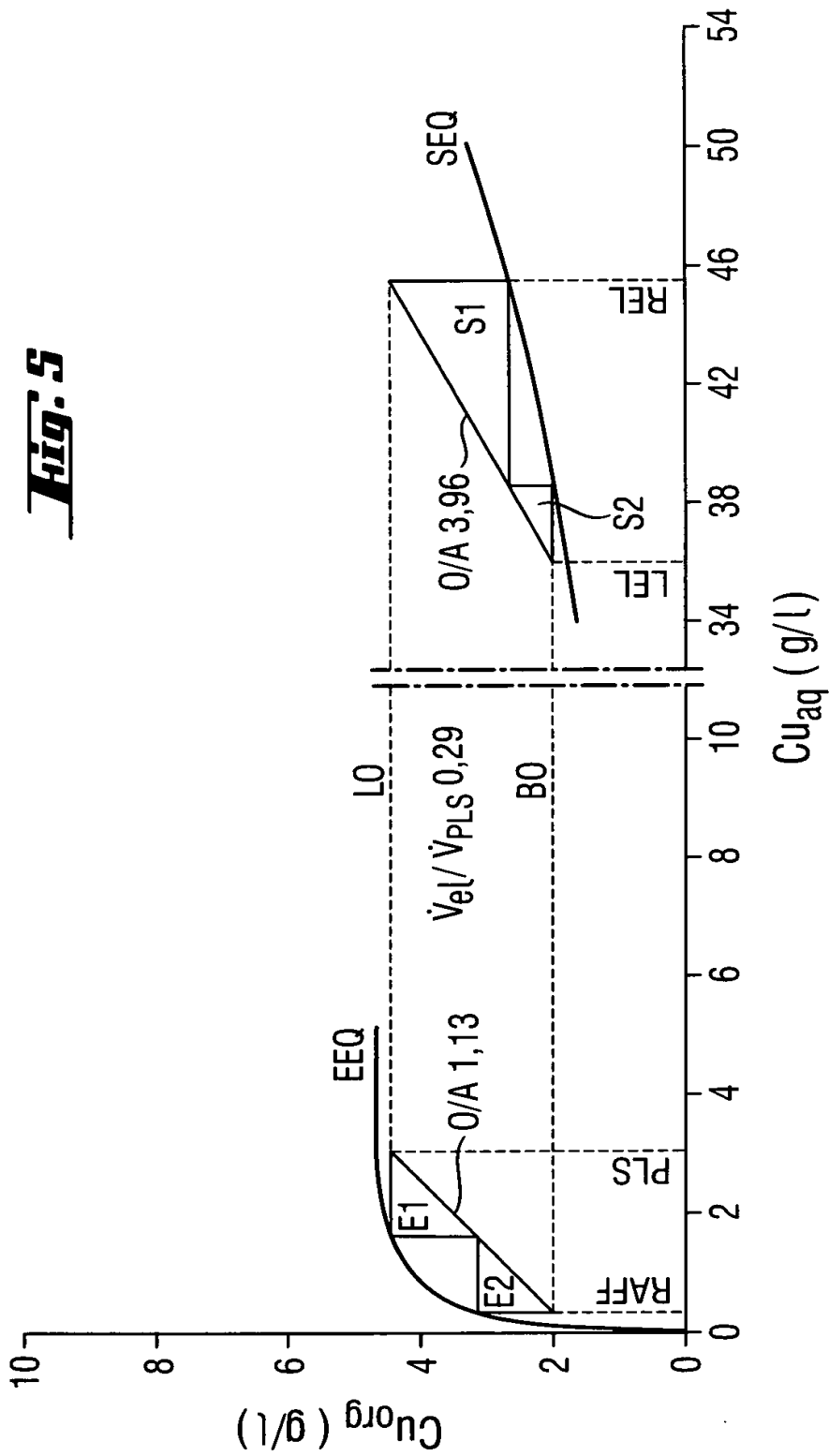
**Fig. 3**



**Fig. 4**

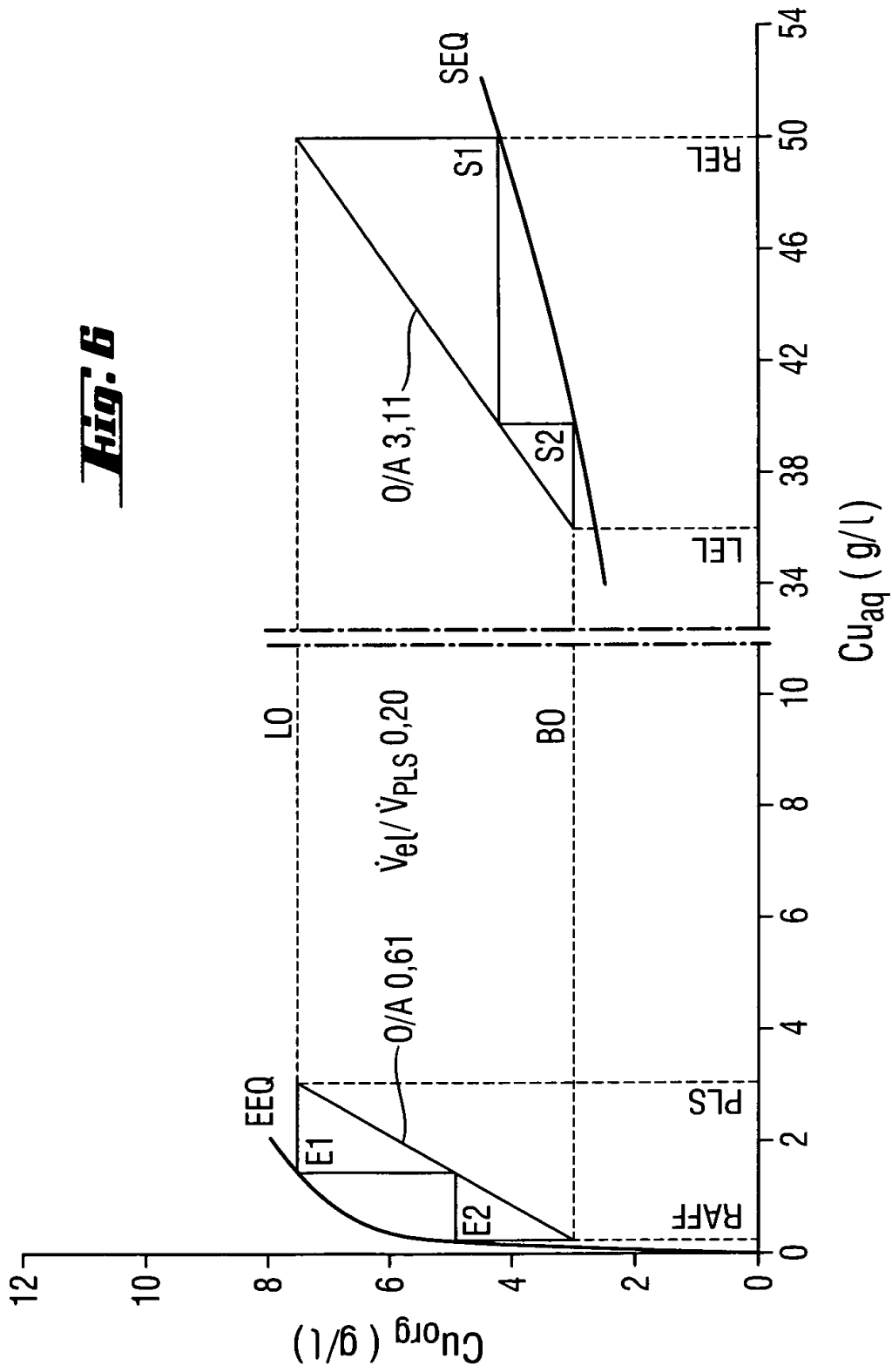


**Fig. 5**



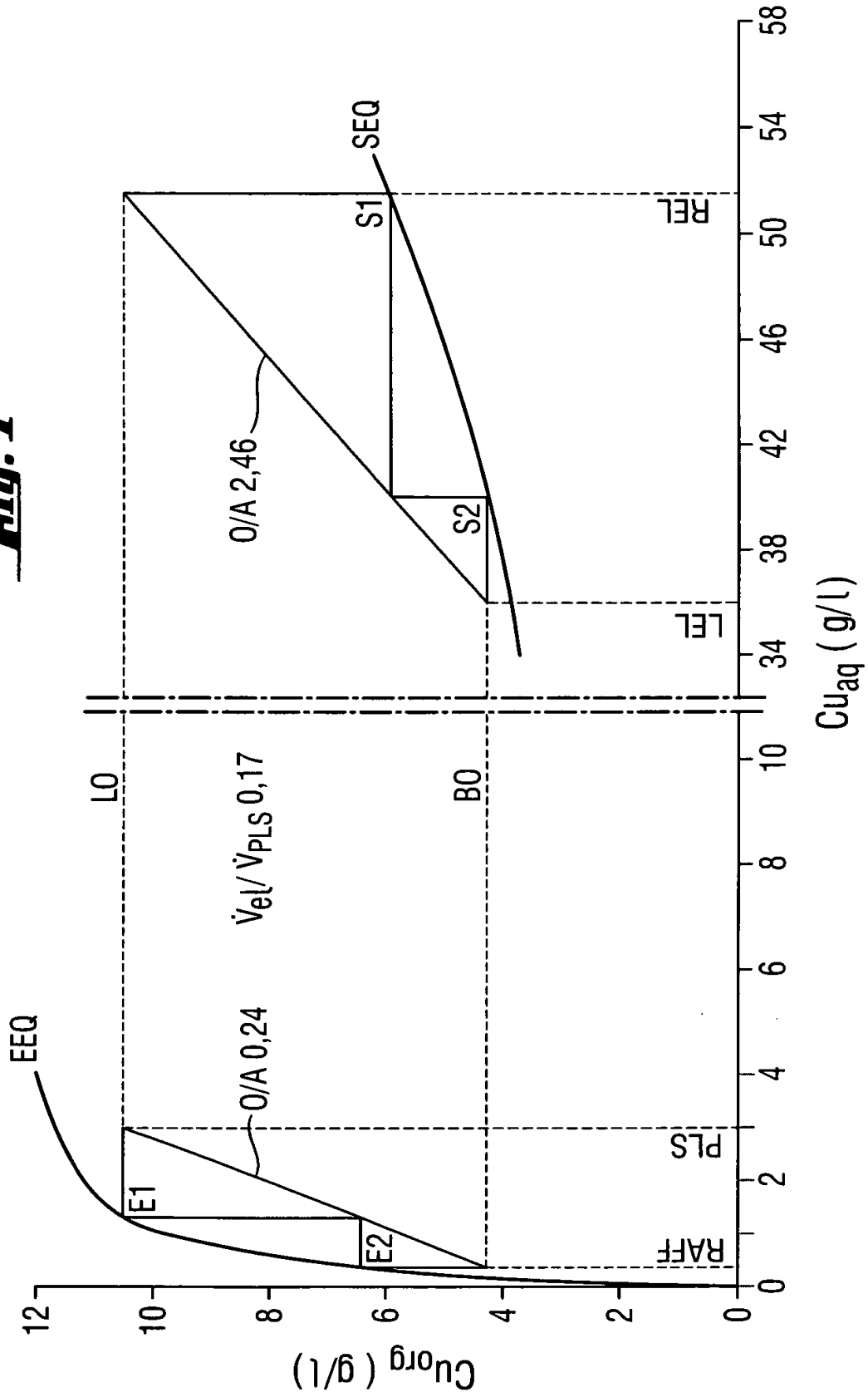
205040" 2966FOOF

**Fig. 6**

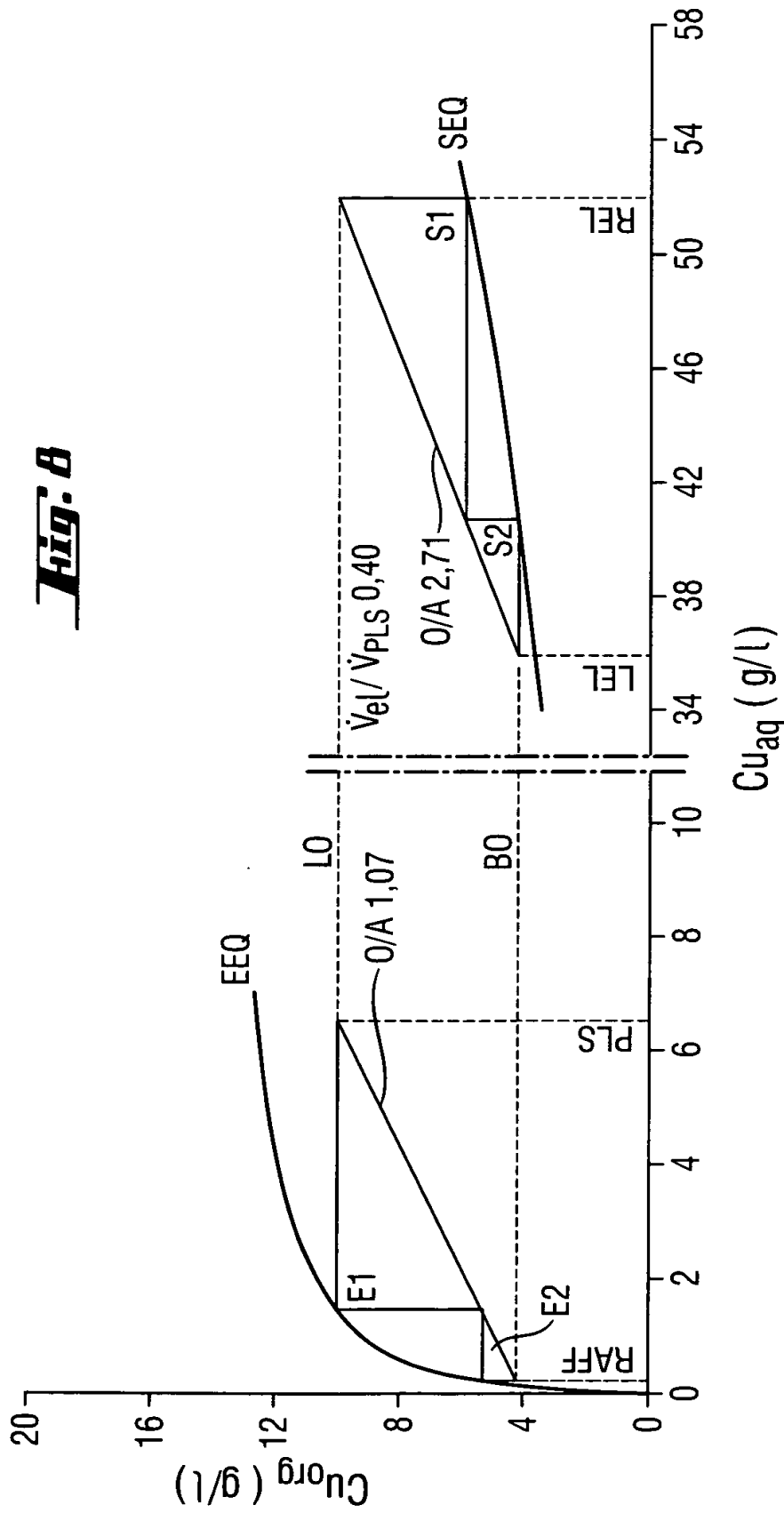


205040 2966T00F

**Fig. 7**



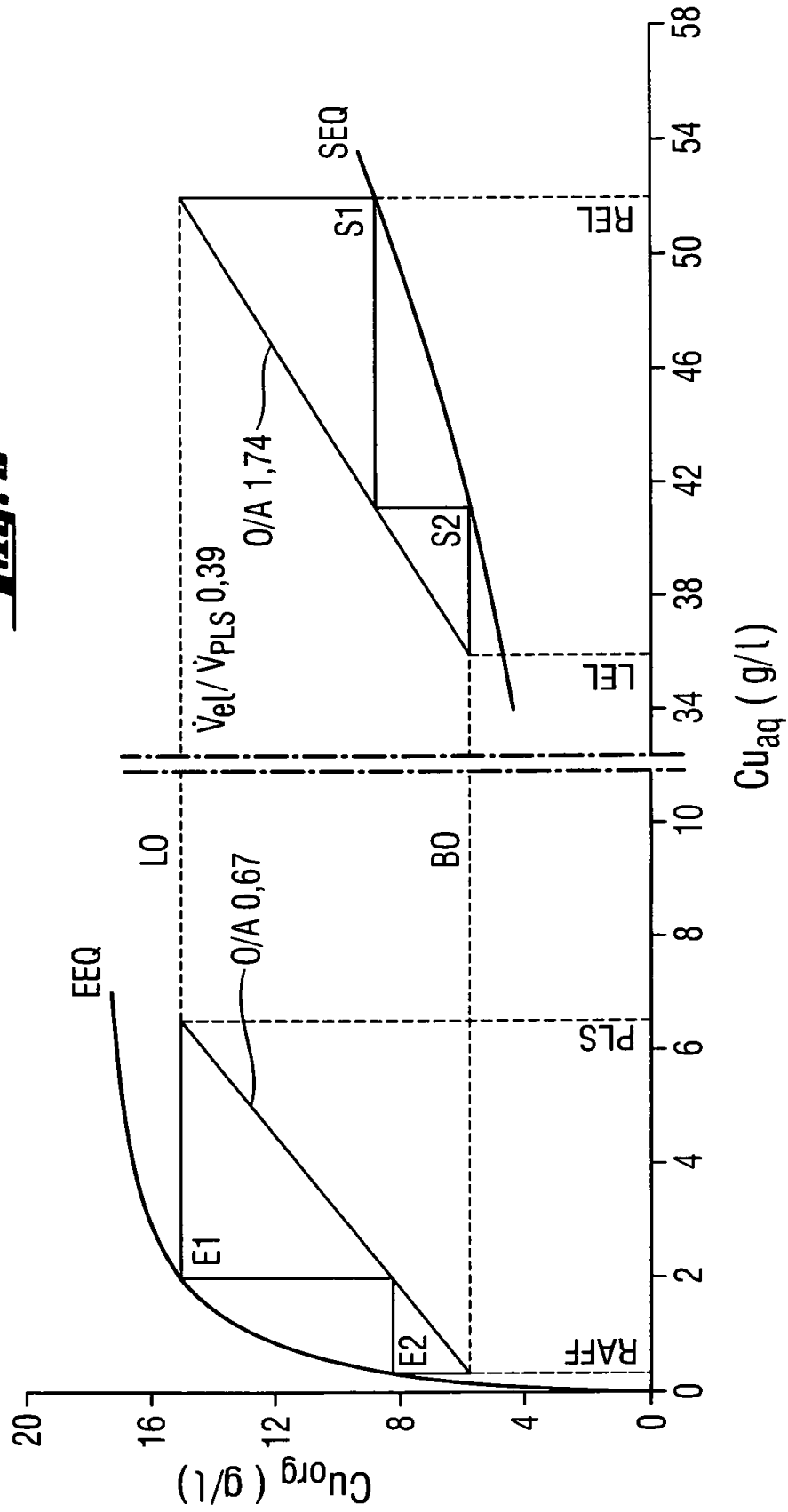
**Fig. 8**



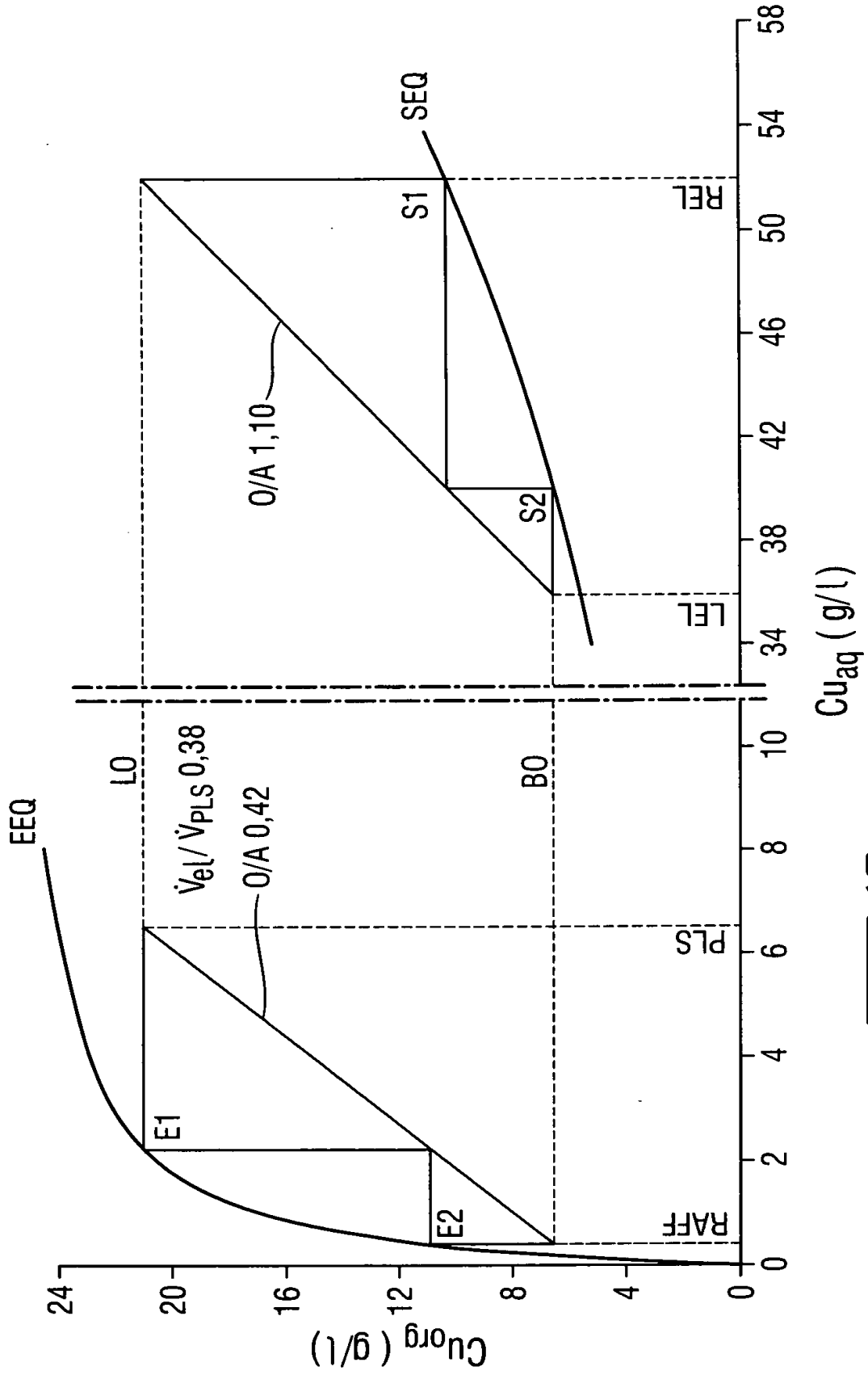


9 / 12

**Fig. 9**



205040" 2966700F



**Fig. 10**

205040 2355 FOOT

**Fig. 11**

